

VIBRAFON CHP
Akoestische plafondhangers

TRILLINGSDEMPING EN GELUIDISOLATIE

VIBRAFON CHP – Akoestische plafondhangers

Productomschrijving Vibrafon CHP en vibrafon CHP HD (Havey Duty) plafondhangers zijn trillingsdempende hangers die tussen het bouwkundige plafond en een vrijhangend plafond kunnen worden aangebracht om de trilling- en geluidoverdracht te beperken. De producten zijn ontwikkeld op basis van SYLOMER trillingsdempend polyurethaan schuim i.s.m. AMC.

Eigenschappen

- Zeer goede trillingsisolerende eigenschappen
- Gemakkelijk en snel aan te brengen
- Economische oplossing
- Verschillende diktes mogelijk
- Levensduur langer dan 50 jaar
- Indicatie trillingsdempende eigenschappen zie tabel, maar deze moeten n.a.v. de belastingen en andere gegevens per project worden berekend

Toepassing

In veel gevallen worden de vibrafon CHP en vibrafon CHP HD akoestische hangers in de plafonds van ruimte in een gebouw geplaatst om de geluidisolatie naar de bovenliggende ruimte sterk te verbeteren, of andersom. Toepassingen zijn slechte isolerende plafonds in appartementen, geluidisolatie in bioscopen, poppodia, buurthuizen, multi-culturele centra, horeca gebouwen

Benodigde informatie

Voor een goed advies is de volgende informatie noodzakelijk:

- Benodigde afveerfrequentie of geluiddemping
- Informatie m.b.t. de statische, dynamische en maximale belasting per hanger
- Tekeningen van de gebouwdelen waarin de producten worden gebruikt
- Details van de constructie waar de VIBRAFON CHP of VIBRAFON CHP HD plafondhanger wordt ingebouwd
- Beschikbare ruimte en hoogte voor het product
- Brandeisen

Afmetingen

Zie onderstaande informatie

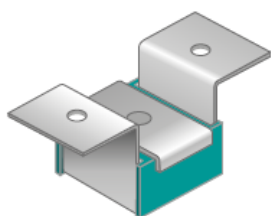

VibraFon CHP 1
Directe montage aan
plafond d.m.v. 2
schroeven

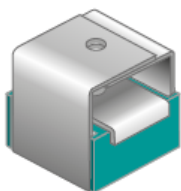
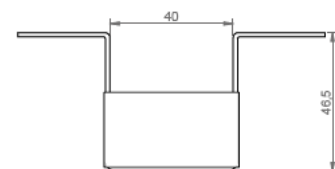
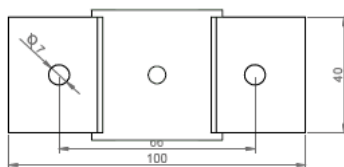

VibraFon CHP 3
Directe montage aan
plafond d.m.v. 1
schroef en sluitring

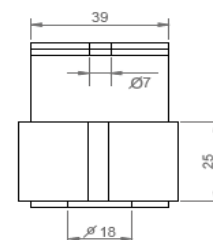
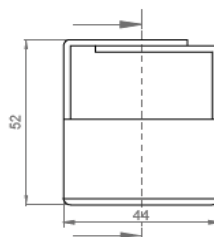



VibraFon CHP 4
directe montage aan
plafond d.m.v. 1
schroef en sluitring

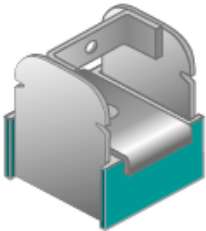
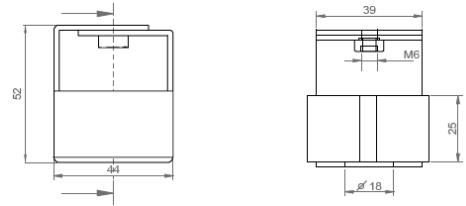

VibraFon CHP Rapid
ontworpen om vast te
klikken aan vrijwel alle
profielen op de markt

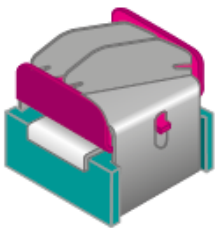
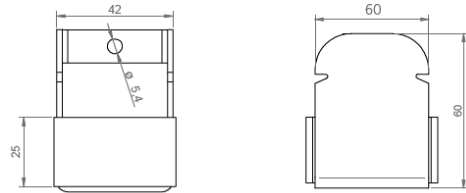

VibraFon CHP Safe
ontworpen om vast te
klikken aan vrijwel alle
profielen op de markt, met
beveiliging tegen ont koppeling
en foute montage

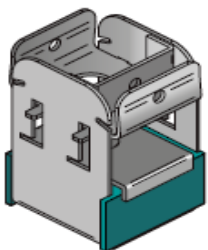
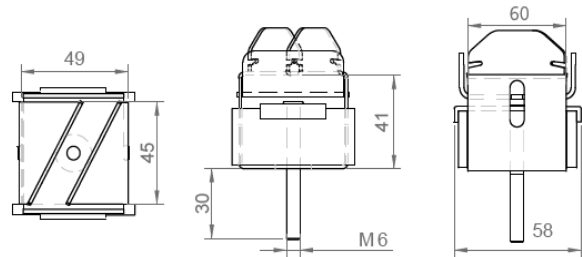

VibraFon CHP Super T47
ontworpen om vast te
klikken aan vrijwel alle
profielen op de markt, met
in breedte verstelbare
mounting

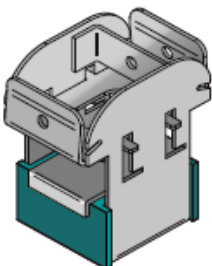
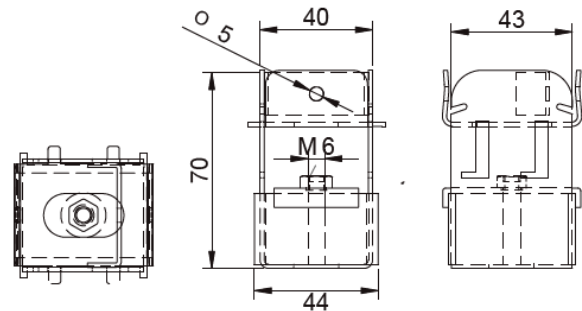

VibraFon CHP Super T60
ontworpen om vast te
klikken aan vrijwel alle
profielen op de markt, onaf-
hankelijk van de profielhoogte,
met beveiliging tegen ont-
koppeling en foute montage

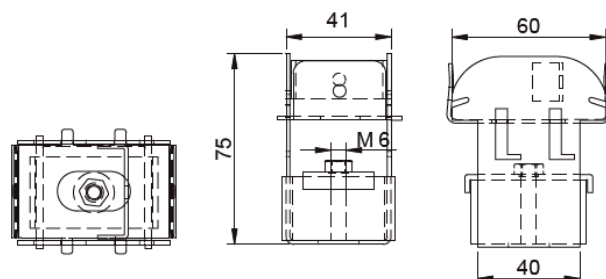

Montage types

Type A: male M6 montage

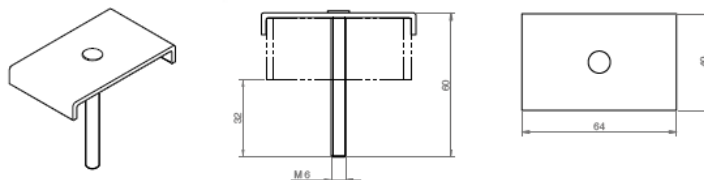

Type B: female M6 montage

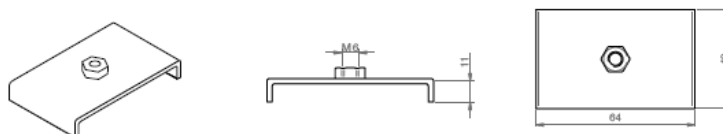

INVERINGSDIAGRAM
Vibrafon CHP 30

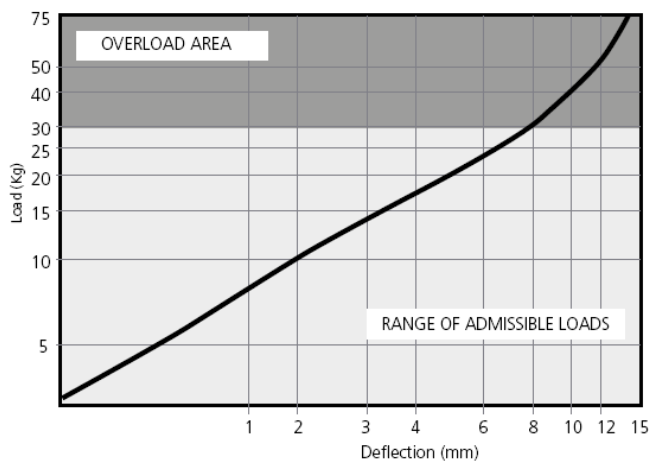

AFVEERFREQUENTIE
Vibrafon CHP 30

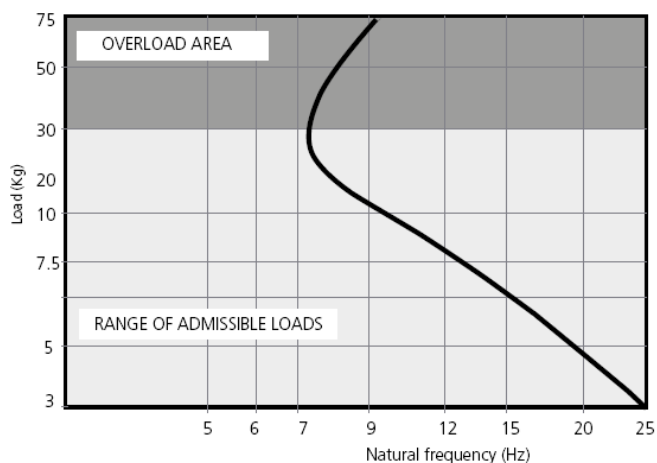



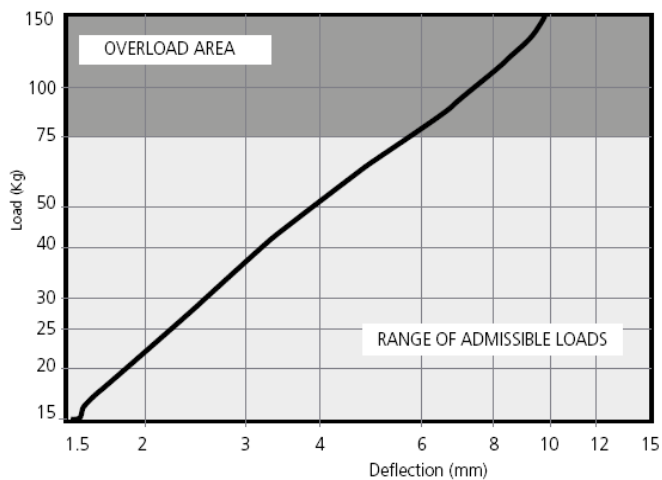



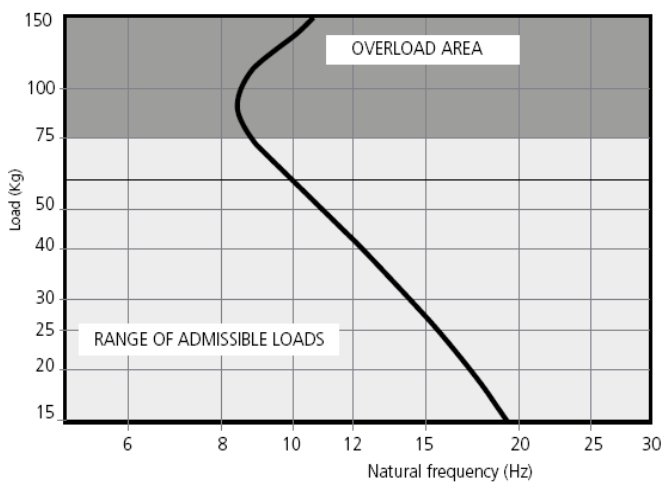

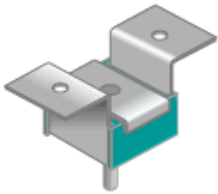

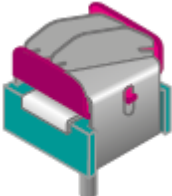

INVERINGSDIAGRAM
Vibrafon CHP 75



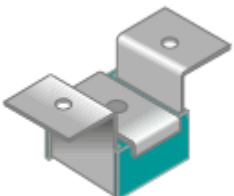





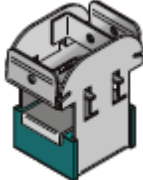

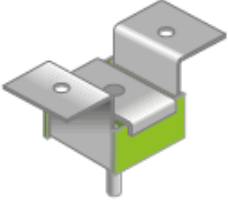

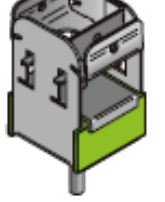

AFVEERFREQUENTIE
Vibrafon CHP 75



Uitvoering	Type	Maximaal gewicht	Artikelnummer
	VIBRAFON CHP 1-30 Type A	30 kg	23501
	VIBRAFON CHP 3-30 Type A	30 kg	23503
	VIBRAFON CHP 4-30 Type A	30 kg	23505
	VIBRAFON CHP RAPID-30 Type A	30 kg	23507
	VIBRAFON CHP SAFE-30 Type A	30 kg	23508
	VIBRAFON CHP T47-30 Type A	30 kg	23821
	VIBRAFON CHP T60-30 Type A	30 kg	23831

Uitvoering	Type	Maximaal gewicht	Artikelnummer
	VIBRAFON CHP 1-30 Type B	30 kg	23509
	VIBRAFON CHP 3-30 Type B	30 kg	23511
	VIBRAFON CHP 4-30 Type B	30 kg	23513
	VIBRAFON CHP RAPID-30 Type B	30 kg	23515
	VIBRAFON CHP SAFE-30 Type B	30 kg	23511
	VIBRAFON CHP T47-30 Type B	30 kg	23822
	VIBRAFON CHP T60-30 Type B	30 kg	23832

Uitvoering	Type	Maximaal gewicht	Artikelnummer
	VIBRAFON CHP 1-75 Type A	75 kg	23517
	VIBRAFON CHP 3-75 Type A	75 kg	23519
	VIBRAFON CHP 4-75 Type A	75 kg	23521
	VIBRAFON CHP RAPID-75 Type A	75 kg	23523
	VIBRAFON CHP SAFE-75 Type A	75 kg	23524
	VIBRAFON CHP T47-75 Type A	75 kg	23841
	VIBRAFON CHP T60-75 Type A	75 kg	23851

Uitvoering	Type	Maximaal gewicht	Artikelnummer
	VIBRAFON CHP 1-75 Type B	75 kg	23525
	VIBRAFON CHP 3-75 Type B	75 kg	23527
	VIBRAFON CHP 4-75 Type B	75 kg	23529
	VIBRAFON CHP RAPID-75 Type B	75 kg	23531
	VIBRAFON CHP SAFE-75 Type B	75 kg	23533
	VIBRAFON CHP T47-75 Type B	75 kg	23842
	VIBRAFON CHP T60-75 Type B	75 kg	23852

Specials

Naast de standaard range zijn er ook een aantal speciale types ontwikkeld voor specifieke toepassingen. Hieronder vindt u een overzicht.

VIBRAFON CHP Side

Plafondhanger welke geschikt is voor zowel zijdelingse als hangende montage

Zijdelingse montage

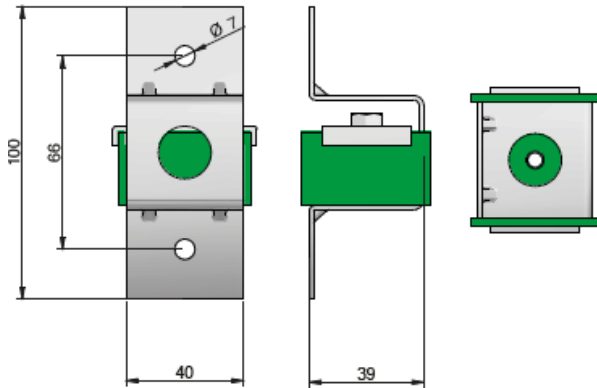

Hangende montage

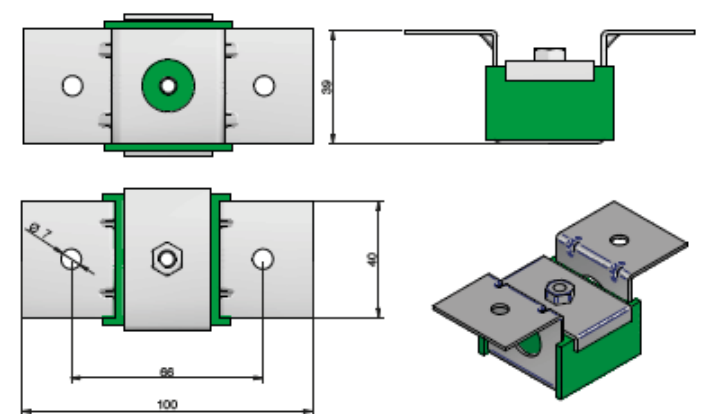

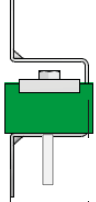
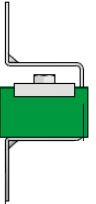
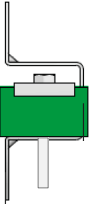
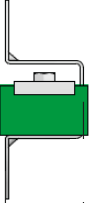
Uitvoering	Type	Maximaal gewicht	Artikelnummer
	VIBRAFON CHP SIDE-30 Type A	30 kg	23573
	VIBRAFON CHP SIDE-30 Type B	30 kg	23510
	VIBRAFON CHP SIDE-75 Type A	75 kg	23574
	VIBRAFON CHP SIDE-75 Type B	75 kg	23526

VIBRAFON CHP SHIFT

Plafondhanger waarbij eerst het frame wordt gemonteerd en later vanaf de zijkant het trillingsdempende element kan worden ingeschoven

Uitvoering	Type	Maximaal gewicht	Artikelnummer
	VIBRAFON CHP SHIFT-30 Type A	30 kg	23863
	VIBRAFON CHP SHIFT-30 Type B	30 kg	23864
	VIBRAFON CHP SHIFT-75 Type A	75 kg	23865
	VIBRAFON CHP SHIFT-75 Type B	75 kg	23866

VIBRAFON CHP HD – Akoestische plafondhangers, belastbaar tot 150 kg

Afmetingen

Zie onderstaande informatie

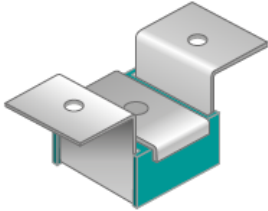

VibraFon CHP HD 1
Directe montage aan
plafond d.m.v. 2
schroeven

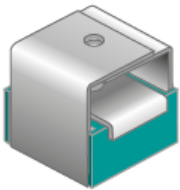
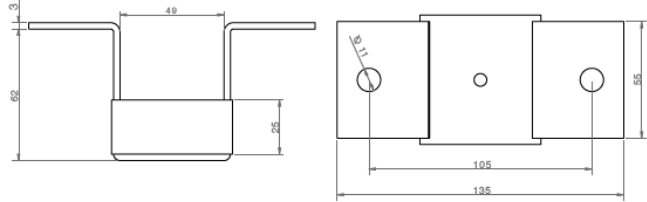

VibraFon CHP HD 2
Directe montage aan
plafond d.m.v. 1
schroef en sluitring

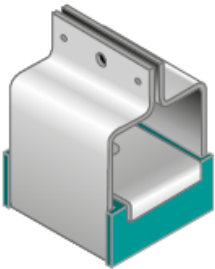
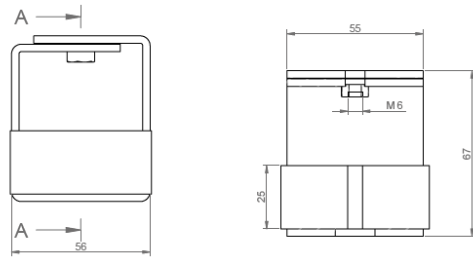

VibraFon CHP 3
montage aan plafond
d.m.v. snelhangers

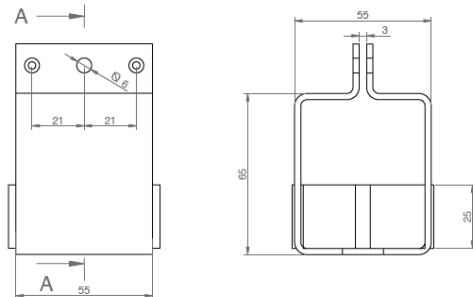

Montage types

Type A: male M6 montage

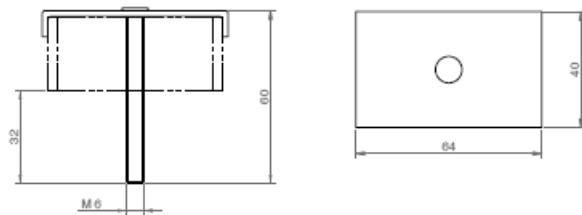
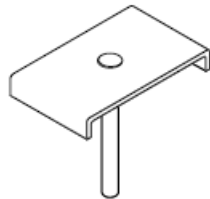

Type B: female M6 montage

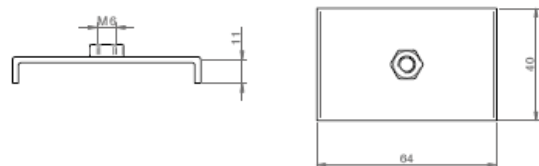
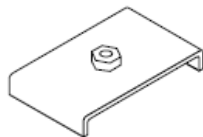

INVERINGSDIAGRAM
Vibrafon CHP HD 60

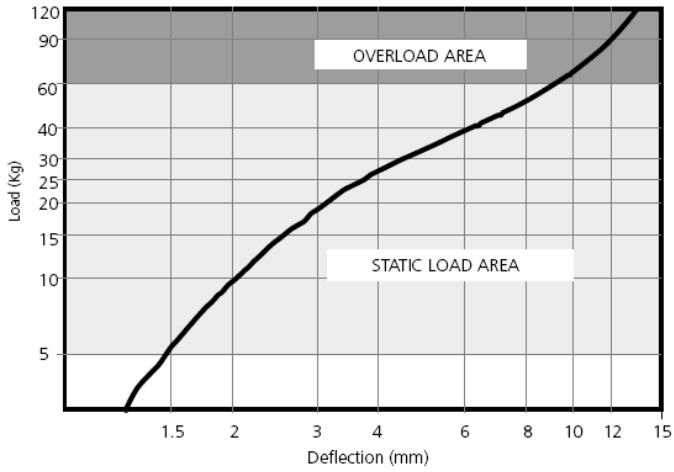

AFVEERFREQUENTIE
Vibrafon CHPHD 60

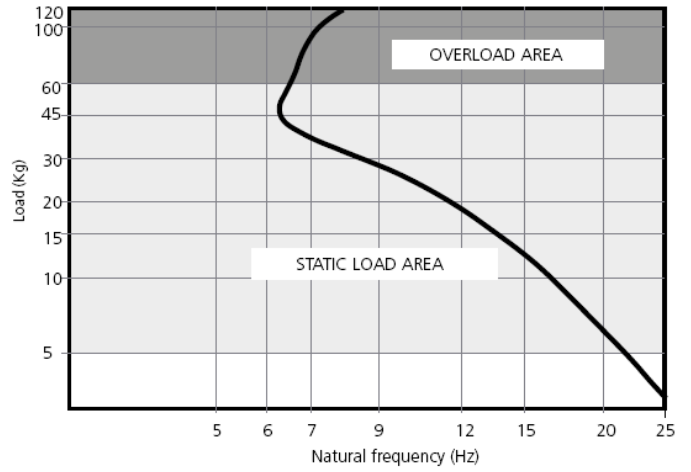



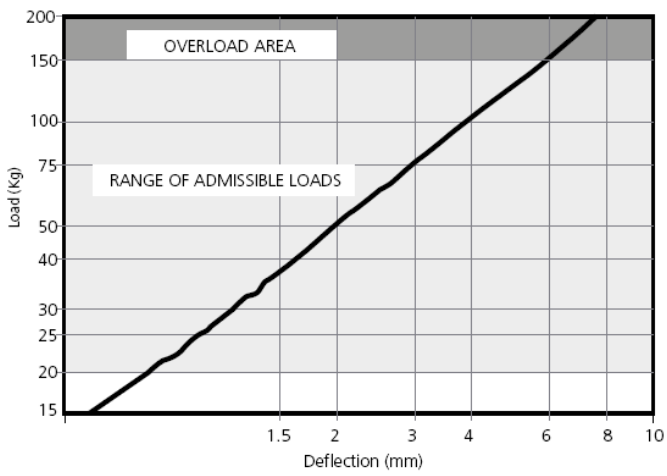



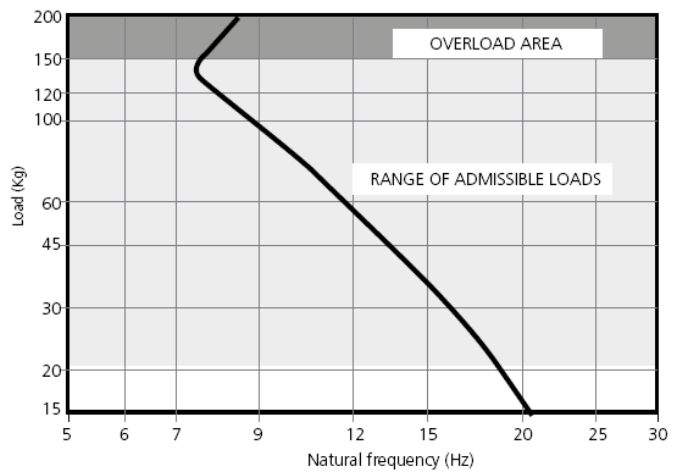

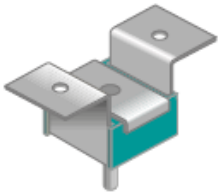

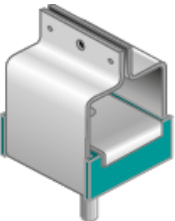
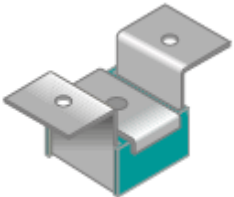
INVERINGSDIAGRAM
Vibrafon CHP HD 150

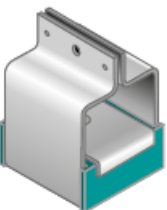

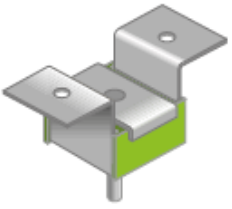
AFVEERFREQUENTIE
Vibrafon CHP HD 150



Uitvoering	Type	Maximaal gewicht	Artikelnummer
	VIBRAFON CHP HD 1-60 Type A	60 kg	23601
	VIBRAFON CHP HD 2-60 Type A	60 kg	23605
	VIBRAFON CHP 3-60 Type A	60 kg	23505
	VIBRAFON CHP HD 1-60 Type B	60 kg	23607
	VIBRAFON CHP HD 2-60 Type B	60 kg	23609
	VIBRAFON CHP HD 3-60 Type B	60 kg	23613

Uitvoering	Type	Maximaal gewicht	Artikelnummer
	VIBRAFON CHP HD 1-150 Type A	150 kg	23617
	VIBRAFON CHP HD 2-150 Type A	150 kg	23621
	VIBRAFON CHP HD 3-150 Type A	150 kg	23623
	VIBRAFON CHP HD 1-150 Type B	150 kg	23625
	VIBRAFON CHP HD 2-150 Type B	150 kg	23629
	VIBRAFON CHP HD 3-150 Type B	150 kg	23631



ATIS International B.V.

Noordhoek 33
3351 LD Papendrecht
Postbus 14
3350 AA Papendrecht

T 31 (0)78 615 00 44
F 31 (0)78 615 49 48
info@atis-international.com
www.atis-international.com

Disclaimer

De omschreven toepassingen en aanbevelingen zijn zo correct mogelijk weergegeven maar zijn vrijblijvend en bieden geen garanties. Bij twijfel over toepassing/verwerking zelf een test uitvoeren of Atis raadplegen. Wij behouden ons het recht om zonder kennisgeving vooraf productgegevens te wijzigen.